



## THEORETICAL ANALYSIS OF A CASCADE REFRIGERATION SYSTEM WITH NATURAL AND SYNTHETIC WORKING FLUID PAIRS FOR ULTRA LOW TEMPERATURE APPLICATIONS

Barış YILMAZ\*, Ebru MANÇUHAN\*\* and Deniz YILMAZ\*\*\*

\*\*\*Marmara University, Faculty of Engineering, Mechanical Engineering Department  
34722, Kadıköy, İstanbul, Turkey,

\*byilmaz@marmara.edu.tr (corresponding author), \*\*emancuhan@marmara.edu.tr

\*\*\*İstanbul Arel University, Faculty of Engineering and Architecture, Mechanical Engineering Department 34295,  
İstanbul, Turkey, denizyilmaz@arel.edu.tr

(Geliş Tarihi: 30.01.2019, Kabul Tarihi: 27.02.2020)

**Abstract:** In this study, a theoretical model is established using Engineering Equation Solver (EES) software in order to investigate the effects of different design and operation parameters on the performance of the cascade systems for Ultra Low Temperature (ULT) between -50 °C and -100 °C. The analysis is performed for natural and synthetic refrigerant pairs to find an environmentally friendly alternative to commercial synthetic refrigerants. Effects of common parameters such as the evaporation temperature of low temperature cycle (LTC), the condensation temperature of high temperature cycle (HTC) and the temperature difference in the cascade heat exchanger (HX) have been investigated with the proposed model. Furthermore, influence of operation parameters including vapor quality of the refrigerant after the expansion valve and the precooler heat exchanger (PCHX) capacity, crucial to reach ULT conditions, on the system performance are examined. This study also contributes to the theoretical evaluation of the feasible natural refrigerant alternatives for ULT applications and the comparison of these refrigerants with synthetic ones in terms of performance and the environmental aspects. It is found that the natural refrigerant R1270/R170 pair results in about 5% better COP and almost half less CO<sub>2</sub> emissions compared to synthetic refrigerant R404A/R508B pair.

**Keywords:** Ultra-Low Temperature, Cascade Refrigeration System, Natural Refrigerants, COP, TEWI

## DOĞAL VE SENTETİK SOĞUTUCU AKIŞKAN ÇİFTLERİ KULLANILAN BİR KASKAD SOĞUTMA SİSTEMİNİN ULTRA DÜŞÜK SICAKLIK UYGULAMALARI İÇİN TEORİK ANALİZİ

**Özet:** Bu çalışmada, ultra düşük sıcaklık (UDS) (-50 °C ile -100 °C) uygulamalarında farklı dizayn ve çalışma parametrelerinin kaskad sistem performansına etkilerini incelemek için EES yazılımı kullanılarak teorik bir model oluşturuldu. Kaskad sistemlerde kullanılan sentetik soğutucu akışkan çiftine çevre dostu bir alternatif bulmak için doğal ve sentetik soğutucu akışkan çiftleri için analiz yapıldı. Önerilen modelde; yüksek sıcaklık çevrimi (YŞÇ) yoğunlaşma ve düşük sıcaklık çevrimi (DŞÇ) buharlaşma sıcaklıkları ve kaskad ısı değiştiricisi sıcaklık farkı gibi parametrelerinin etkileri incelendi. Ayrıca, UDS uygulamalarında aşırı soğutma şartlarına ulaşabilmek için kritik çalışma parametreleri olan genişleme valfi sonrası soğutucu akışkanın buhar kalitesi ve ön soğutma amaçlı ısı değiştiricisi kapasitesinin sistem performansına etkileri incelendi. Bu çalışmada UDS uygulamalarında kullanılabilecek doğal akışkan alternatiflerinin performans ve çevresel etkileri açısından teorik olarak karşılaştırılmalarına katkıda bulunmaktadır. Yapılan analiz çalışmaları sonucunda soğutma sisteminde R1270/R170 doğal soğutucu çiftinin kullanılması ile, R404A/R508B sentetik soğutucu çiftine kıyasla %5 civarında daha iyi sistem performans katsayısı ve yaklaşık olarak yarısı kadar CO<sub>2</sub> emisyon salımı gerçekleştiği belirlendi.

**Anahtar Kelimeler:** Ultra Düşük Sıcaklık, Kaskad Soğutma Sistemi, Doğal Akışkanlar, STK, TEWI

### NOMENCLATURE

#### Abbreviations

COP	coefficient of performance
EES	engineering equation solver
GWP	global warming potential
$h$	specific enthalpy [kJ kg <sup>-1</sup> ]
HTC	high temperature cycle
HX	heat exchanger
IHX	internal heat exchanger

LTC	low temperature cycle
$\dot{m}$	mass flow rate [kg s <sup>-1</sup> ]
NBP	normal boiling point
ODP	ozone depletion potential
P	pressure
PCHX	precooler heat exchanger
$\dot{Q}$	heat transfer rate [kW]
T	temperature [°C, K]
$\Delta T$	temperature difference
TEWI	total equivalent warming impact

$\dot{W}$	power [kW]	E	electric
<i>Greek symbols</i>		Evap	evaporator
$\eta$	efficiency	FR	freezing
$\alpha$	recycling factor (%)	HP	high pressure
$\beta$	electrical regional conversion factor (kg CO <sub>2</sub> /kWh)	HTC	high temperature cycle
<i>Subscripts</i>		in	input
C	condensation	LP	low pressure
CAS	cascade	LTC	low temperature cycle
Cond	condenser	M	mechanical
Comp	compressor	out	output
CR	critical	p	pump
DESUP	desuperheating	S	isentropic
		SUB	subcooling
		SUP	superheating
		tot	total

## INTRODUCTION

Refrigeration systems can be categorized depending on the evaporation temperature aimed to be achieved. The refrigeration processes performed between -50 °C and -100 °C are called Ultra Low Temperature (ULT) applications according to ASHRAE Handbook classification (ASHRAE Handbook, 2010). The refrigeration systems operating at these temperature levels are mostly utilized for the storage of biological samples such as bacteria, bone marrow, cell cultures and DNA. Furthermore, these systems are used to liquify gases in petro chemistry industry. For many medical and industrial applications, the ULT refrigeration has not been accomplished efficiently in single-stage and multistage systems due to the limitations either in the thermo-physical properties of refrigerants or the cascade systems. The essential criteria of the systems operating at these low temperatures are specified in detail in ASHRAE Handbook, 2010.

Synthetic refrigerants consisting of Hydrofluorocarbons (HFCs) and Chlorofluorocarbons (CFCs) are chosen in most industrial refrigeration systems because of their superior cooling properties. In cascade systems, an appropriate selection of refrigerants to operate in the low and high temperature cycles should be made in order to obtain high COP. Generally, the synthetic refrigerants such as R404A, R507A, and R134a are used in HTC whereas the refrigerants such as R23 and R508B are used in LTC of systems in order to reach ULT levels. However, it is known that such compounds have adverse effects on ozone layer and thereby on environment. Recently, natural refrigerants started to be utilized for replacement of the synthetic ones. Among the natural fluids are water, carbon dioxide and various hydrocarbon compounds (propane, ethane, propylene, etc.) (Van Orshoven et al., 1993). Several organic fluids such as R23, R32, R125, R143a, R134a, R218, R170 and ammonia (R717) are also utilized as the working fluid of the power generation systems, especially for low grade energy source applications for instance Organic Rankine Cycle (ORC) (Vidhi et al., 2013; Vijayaraghavan et al., 2005). To achieve an environmentally friendly solution

in ULT applications, the natural refrigerants such as R290 (Propane), R1270 (Propylene) and R717 (Ammonia) may be chosen in HTC, and R170 (Ethane) or R1150 (Ethylene) may be selected in LTC. Moreover, the mixtures of different natural refrigerants can alternatively be used in LTC in order to achieve ULT levels such as nitrous oxide (N<sub>2</sub>O) alone and its mixture with CO<sub>2</sub> (Bhattacharyya et al. 2005; Syaka et al. 2011; Bhattacharyya, et al. 2009; Nicola, et al. 2011; Gong et al. 2009).

In literature, there are plenty of theoretical and experimental studies about cascade systems for low evaporation temperature of LTC between -30 °C and -50°C (Lee et al., 2006; Dopazo et al. 2009; Getu and Bansal, 2008; Messineo, 2012; Yilmaz et al., 2014; Bingming et al. 2009; Dopazo et al., 2011; Yilmaz et al. 2018). However, there are few theoretical studies investigating the effects of operation parameters on the COP for different refrigerant pairs in ULT applications. Sarkar et al. (2013), performed a theoretical analysis and optimization study to investigate the effects of operation parameters on the COP for ULTs between -85 °C and -55 °C. In that study; ethane, ethylene and nitrous oxide were used in HTC while the ammonia, propane and propene were used in LTC as working fluids in order to evaluate the refrigeration system performance. They concluded that the COP increased for ethane and ethylene whereas the COP decreased for N<sub>2</sub>O. Parekh and Tailor (2011), developed a mathematical model of a cascade system using ozone-friendly refrigerants pair (R507/R23) in order to optimize the design and operating parameters. Model results showed that when the evaporation temperature was decreased from -50 °C to -80 °C and the overall COP reduced from 1.232 to 0.785. Consequently, they stated that the lowest value of evaporation temperature of LTC resulted in the lowest COP. Wadell (2005), analyzed experimentally a cascade system using R134a and R508B refrigerants in high temperature and low temperature cycles, respectively. In experiments, the evaporation temperature of LTC was varied from -86 °C to -79 °C and the studied mass flow rates of refrigerant were between 50-70 g/min. It was concluded that if the evaporator is designed as

microchannel and enhanced surface, better performances may be achieved. Kruse and Russmann (2006), analyzed and compared theoretically trans-critical CO<sub>2</sub>/N<sub>2</sub>O system and R134a/R23 system. Their results showed that N<sub>2</sub>O is a good alternative refrigerant to R23 in LTC with respect to the performance and the environmental trace. Utilization of R134a, R717 and hydrocarbons was proposed in HTC of the cascade system. They also concluded that trans-critical CO<sub>2</sub>/N<sub>2</sub>O system is more sustainable solution instead of R717 and hydrocarbons. Kılıçaraslan et al. (2010), determined and compared the COP and irreversibility of the cascade system using a large family of environmentally friendly refrigerant pairs. They concluded that the cascade system's COP increases and the irreversibility decreases with rising evaporation temperature of LTC for all selected refrigerant pairs. Mancuhan (2019) theoretically analyzed a refrigeration system with flash intercooling. Modeling of system was done by optimizing the intermediate pressure at given evaporation and condensation temperature values for all medium temperature application's (R717, R134a and R152a) and low temperature application's refrigerants (R290, R404A and R507A). Sun et al. (2019) evaluated the potential of refrigerant and found out which refrigerant couple performs better in cascade refrigeration system. In the considered 28 refrigerant pairs, R161 was suggested for use in HTC, and R41 and R170 were suggested for use in LTC. Babiloni et al. (2019) presented a comprehensive review on available literature on ULT applications. They concluded that the current status of the technology offers the most promising low GWP alternatives, although the existing regulations do not limit high GWP refrigerants used in ULT applications.

The present study proposes a mathematical model for a cascade ULT application with an Internal Heat Exchanger and a precooler heat exchanger in LTC side to determine the optimum design and operating parameters and produce the data for the future experimental applications. Earlier works are mainly focused on the theoretical and experimental analysis of cascade systems operating at evaporation temperatures of LTC between -30 °C and -50 °C (Lee et al., 2006; Dopazo et al. 2009; Getu and Bansal, 2008; Messineo, 2012; Yılmaz et al., 2014; Bingming et al. 2009; Dopazo et al., 2011; Yılmaz et al. 2018). There are limited number of theoretical studies about cascade ULT system in literature. In addition, no study is found on two crucial operation parameters; vapor quality of the refrigerant after the expansion valve of the LTC and the PCHX capacity. These parameters are critical for the LTC subcooling processes which are required to reach ULT levels and affect significantly the system COP. The key contributions of this work can be summarized as follow; performing the theoretical analysis of a unique cascade system operating at ultra-low temperature conditions between -50 °C and -100 °C and evaluating the feasible natural refrigerant alternatives in terms of the increasing the cascade system performance and decreasing the harmful environmental effects.

## BACKGROUND

### Physical and Environmental Evaluations of Refrigerants

The most convenient refrigerant in a refrigeration application can be decided based on its important characteristics such as Ozone Depletion Potential (ODP), Global Warming Potential (GWP), toxicity, flammability etc. along with the operating and design conditions. Additionally, Total Equivalent Warming Impact (TEWI), a measure of the trace of refrigerants on the environment including both the direct and indirect global warming effects of the refrigeration systems, is calculated. The direct effect represents the release of refrigerant directly to the atmosphere. On the other hand, the indirect effect corresponds to the CO<sub>2</sub> emissions due to fossil fuel consumption for energy production to drive the refrigeration system during its life time. TEWI comparison performed using the following correlation proposed by AIRAH (2012), provides a detailed environmental evaluation of the system.

$$TEWI = GWP_{ref} \left( m_{ref} \times L_{annual} \times N + m_{ref} \times (1-\alpha) \right) + (E_{annual} \times \beta \times N) \quad (1)$$

where N is the system lifetime (year),  $m_{ref}$  is the total refrigerant charge (kg),  $L_{annual}$  is the refrigerant leakage rate (%),  $\alpha$  is the recycling factor,  $E_{annual}$  is energy consumed per year (kWh/year) and  $\beta$  is the electricity regional conversion factor (kgCO<sub>2</sub>/kWh).

The physical and environmental properties of refrigerants that are subject of this study are given in Table 1.

In this study, one natural and one synthetic refrigerant pairs are used. As the synthetic refrigerant pair, R404A/R508B is chosen. R404A has the evaporation temperature about -40 °C without falling into vacuum pressure. Therefore, it can be used HTC refrigerant in cascade systems. R508B has a very low boiling point of -86.9 °C at 1 atm. Therefore, it can be used LTC refrigerant in ultra-low refrigeration system as these systems operate at just above R508B's boiling point. R508B is also non-toxic and non-flammable. On the other hand, R1270/R170 with negligible GWP offers a natural alternative solution pair for ultra-low refrigeration systems. In a cascade refrigeration system, R1270 is utilized in HTC and R170 is used in LTC. However, they have a safety rating of A3 which shows highly flammable property according to ASHRAE Standard 34 (2016). Hence, using R1270 and R170 requires additional safety measures.

### Ultra-low Temperature Refrigeration Systems

Operating at ultra-low temperature levels, i.e. between -50 °C and -100 °C, with a single-stage system is difficult to reach since the parameters such as compression ratio, ambient air temperature and refrigerant properties limit

the system operation. The lowest temperature level that can be reached with single-stage refrigeration system is around  $-40\text{ }^{\circ}\text{C}$  to  $-45\text{ }^{\circ}\text{C}$  in industrial applications. On the other hand, two-stage cascade systems do not have this limitation as they can efficiently achieve the ULTs between  $-45\text{ }^{\circ}\text{C}$  and  $-80\text{ }^{\circ}\text{C}$ .

**Table 1.** The physical and environmental properties of refrigerants used in this study (IPCC, Climate Change, 2013)

Refrigerants	HTC		LTC	
	R404A	R1270	R508B	R170
$T_{CR}$ ( $^{\circ}\text{C}$ )	72	92	14	32
$P_{CR}$ (bar)	37.3	44.6	39	47.6
NBP ( $^{\circ}\text{C}$ )	-46.4	-47.7	-86.9	-89.3
$T_{FR}$ ( $^{\circ}\text{C}$ )	Not determined	-185	Not determined	-
ODP	0	0	0	0
GWP	3922	1.8	11698	6
Safety Class	A1	A3	A1	A3

The schematic diagram of the proposed ULT cascade refrigeration system consisting of high and low temperature cycles is shown in Figure 1. Main components of the HTC are two compressors, an air-cooled condenser, an internal heat exchanger, a primary expansion valve and a secondary expansion valve. HTC compressors are operated between two pressure levels. Low and high pressure compressors sustain a reliable operation if the difference between the evaporation and the condensation pressures is high. An internal heat exchanger of HTC (IHX<sub>HTC</sub>) provides subcooling effect before entering the primary expansion valve between state 8 and state 11 and protects the compressor from two phase flow as shown in Figure 1. Meanwhile, low quality vapor exits from the secondary expansion valve (state 9) and becomes saturated vapor at state 10. A cascade HX is located between the high and low temperature cycles. In the cascade HX, the refrigerant in the LTC cycle is condensed whereas the liquid phase refrigerant evaporates in the HTC cycle.

The components of the LTC are shown in Figure 1 which are a compressor, an expansion valve, an evaporator, an IHX<sub>LTC</sub> and a PCHX. The IHX<sub>LTC</sub> functions as a subcooler and a suction gas heater for compressor of LTC. Therefore, it subcools the refrigerant at the outlet of cascade HX and superheats the refrigerant at the inlet of the compressor. Thus, a more reliable operation for the LTC compressor is achieved. Moreover, the desuperheating of the refrigerant is essential since the exit temperature of LTC compressor is relatively higher than the conventional ULT applications. Minh et al. (2006), stated that utilizing the IHX<sub>LTC</sub> for subcooling helps to protect the compressor from two-phase flow and provides the low quality of refrigerant entering the evaporator so that it improves the system COP. Desuperheating of the refrigerant is provided by a PCHX located before the cascade HX. The PCHX is assumed to be a water pumped cycle having inlet and outlet temperatures of  $10\text{ }^{\circ}\text{C}$  and  $35\text{ }^{\circ}\text{C}$ , respectively. It lowers

the LTC refrigerant's temperature to  $55\text{ K}$  higher than  $T_{CAS,E}$ .

The desuperheating degree ( $\Delta T_{DESUP}=T_1-T_{1a}$ ) is defined as the difference between the exit temperature of compressor ( $T_1$ ) and inlet temperature of the cascade condenser ( $T_{1a}$ ). The subcooling and desuperheating processes let the theoretical model can be applied to the real applications. Figure 2 presents the pressure-enthalpy diagram corresponding to the investigated cascade system.

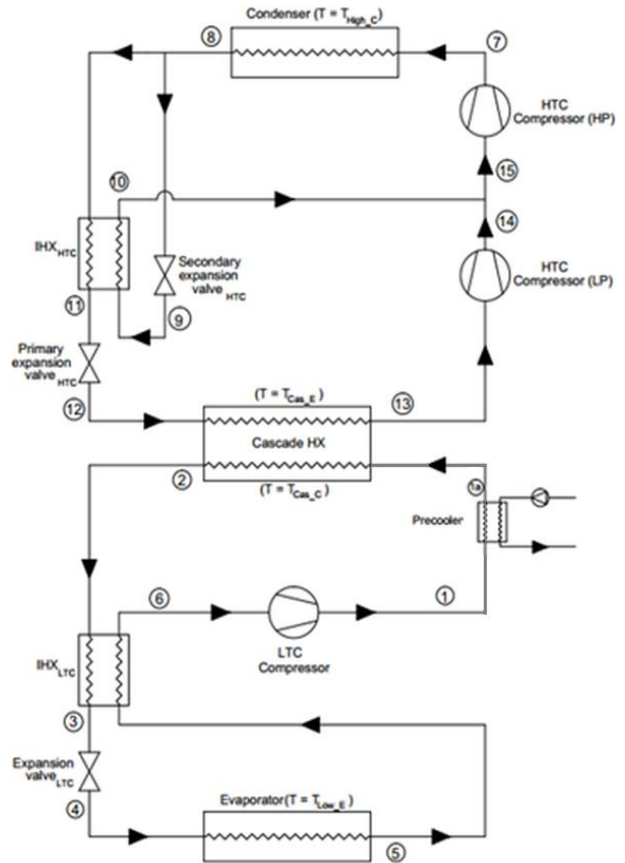
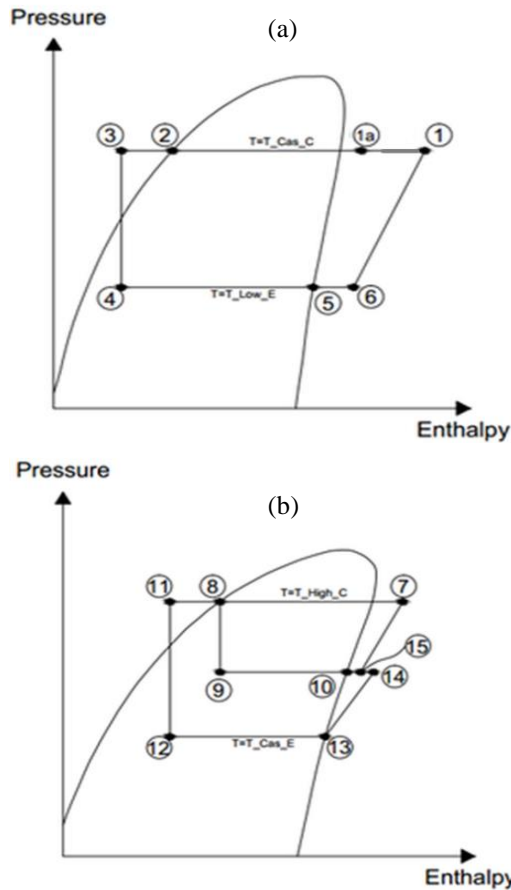

**Figure 1.** Schematic view of a cascade refrigeration system

### Thermodynamic Analysis

The mathematical model of the cascade refrigeration system is developed based on energy and mass conservation equations. Expressions are obtained for each components of both high and low temperature cycles.

The developed model of the system is implemented to the Engineering Equation Solver (EES) software (Klein, 2017). EES software having a high accuracy thermodynamic database involving many of pure substances and mixtures is commonly used for thermodynamic analysis of the cyclic devices.



**Figure 2.** P-h diagrams of the investigated cascade system; for a) LTC, b) HTC

In our system analysis, the following assumptions are taken into account:

- Heat transfer in heat exchangers is performed as isobaric process.
- Refrigerants are expanded with constant enthalpy (isenthalpic) in expansion valves.
- Pressure drops in the system pipes and heat exchangers are neglected.
- The change in potential and kinetic energy is neglected.

In Table 2, we set the variable operating and constant design parameters for our system. In most of the applications, the cascade HX is designed to have 60 K difference, as in the industrial applications, between the  $T_{CAS,E}$  and the refrigerant outlet temperature from the PCHX ( $T_{1a}$ ). Therefore, the maximum temperature difference between the  $T_{CAS,E}$  and  $T_{1a}$  is assumed to be constant at 55 K as in the reference (SWEP Company, 2016).

The subcooling degree of LTC ( $\Delta T_{SUB\_LTC}$ ) is determined depending on the following constraints:

- The vapor quality after the expansion valve should not be lower than 0.10 (Cengel and Boles, 2007) so that it is chosen to be 0.15.
- While the liquid at the cascade condenser outlet (State 2) is cooled, the vapor at the LTC compressor inlet (State 6) is heated by  $IHX_{LTC}$  utilization. If the suction gas temperature of the compressor (State 6) gets higher, the discharge temperature (State1) and the desuperheating requirement increases. To prevent the increase in desuperheating, the LTC refrigerant is cooled by a PCHX. The PCHX is chosen to be a water pumped cycle working between 10 °C and 35 °C. The maximum desuperheating capacity of the PCHX is chosen to be 6 kW as a design condition.

**Table 2.** Design and operating parameters used in the model

Design parameters		
Compressor isentropic efficiency( $\eta_S$ ) (Brunin et al.,1997)		$\eta_S = 0.874 - 0.0135 \frac{P_H}{P_L}$
Mechanical efficiency ( $\eta_M$ ) (Brunin et al.,1997)		$\eta_M = 0.959 - 0.00642 \frac{P_H}{P_L}$
Compressor electric motor efficiency( $\eta_E$ ) (Brunin et al.,1997)		0.90
Compressor Overall Efficiency( $\eta_C$ )		$\eta_C = \eta_S \eta_M \eta_E$
Effectiveness of cascade HX		1.0
System refrigeration capacity ( $Q_{EVAP}$ )	kW	11
The temperature difference between $T_E$ and $T_{Space}$	K	6
The temperature difference in cascade HX ( $\Delta T_{CAS}$ )	K	8
The maximum temperature difference between the $T_{CAS,E}$ and $T_{1a}$ (SWEP Company, 2016)	K	55
Superheating in LTC evaporator	K	6
Superheating in evaporator side of cascade HX	K	5
Operating Parameters		
LTC evaporation temperature range ( $T_E$ )	°C	-60 to -86
HTC condensation temperature ( $T_C$ )	°C	30 to 55
The evaporation temperature of cascade HX ( $T_{CAS,E}$ )	°C	-40 to -20
The minimum vapor quality after the expansion valve	-	0.15
The maximum desuperheating capacity of PCHX	kW	6

- Power consumption of water pump is assumed to be negligible.
- The temperature values of State 11 and State 9 of HTC are set to 8.67 °C and -5 °C, respectively. These values are determined based on the compressor catalog data (GEA Germany, 2016).

### Model equations

The cascade system is modelled using Thermodynamics laws. The derived mass and energy equations are presented below for each component of the system. The corresponding schematics and diagrams are given in Figures 1 and 2.

Compressor power consumption of LTC is defined as:

$$\dot{W}_{LTC} = \dot{m}_{LTC,in}(h_1 - h_6) \quad (1)$$

where the mass flow rate of compressor inlet is

$$\dot{m}_{LTC,in} = \dot{m}_6 \quad (2)$$

Total compressor power consumption of HTC is given as:

$$\dot{W}_{HTC} = \dot{m}_{HTC_{LP},in}(h_{14} - h_{13}) + \dot{m}_{HTC_{HP},in}(h_7 - h_{15}) \quad (3)$$

where the mass flow rates inlet to the low pressure and high pressure compressors of HTC are as follows;

$$\dot{m}_{HTC_{LP},in} = \dot{m}_{13} \quad (4)$$

$$\dot{m}_{HTC_{HP},in} = \dot{m}_{15} = \dot{m}_{10} + \dot{m}_{14} \quad (5)$$

Total refrigerant mass flow rate of HTC is

$$\dot{m}_{HTC_{Total}} = \dot{m}_{HTC_{HP},in} \quad (6)$$

The rate of heat is rejected by the condenser of HTC is calculated as:

$$\dot{Q}_{HTC_{Cond}} = \dot{m}_{HTC_{Total}}(h_8 - h_7) \quad (7)$$

The heat transfer rate into the cascade HX is defined as:

$$\dot{Q}_{CAS} = \dot{m}_{HTC_{LP},in}(h_{13} - h_{12}) = \dot{m}_{LTC,in}(h_{1a} - h_2) \quad (8)$$

The refrigeration capacity of LTC evaporator is determined as:

$$\dot{Q}_{LTC_{Evap}} = \dot{m}_{LTC,in}(h_5 - h_4) \quad (9)$$

The heat transfer rate into the IHX of HTC and IHX of LTC are, respectively:

$$\dot{m}_{HTC_{LP},in}(h_8 - h_{11}) = (\dot{m}_{HTC} - \dot{m}_{HTC_{LP}})(h_{10} - h_9) \quad (10)$$

$$\dot{m}_{LTC,in}(h_2 - h_3) = \dot{m}_{LTC,in}(h_6 - h_5) \quad (11)$$

Energy balance for the adiabatic mixing process between the low pressure and the high pressure compressors of HTC:

$$\dot{m}_{HTC_{LP},in}h_{14} + (\dot{m}_{HTC} - \dot{m}_{HTC_{LP}})h_{10} = \dot{m}_{HTC,in}h_{15} \quad (12)$$

Desuperheating capacity of the PCHX of LTC can be defined as:

$$\dot{Q}_{PC_{HX}} = \dot{m}_{LTC,in}(h_1 - h_{1a}) \quad (13)$$

And finally, the overall COP of the cascade system is determined by:

$$COP = \frac{\dot{Q}_{LTC_{Evap}}}{\dot{W}_{LTC} + \dot{W}_{HTC}} \quad (14)$$

## RESULTS AND DISCUSSION

The synthetic refrigerant pair of R404A/R508B is reliable choice to be used in ULT operations in a cascade system. However, these refrigerants are not environmentally friendly because of their high GWPs. A natural refrigerant alternative couple may be R1270/R170 having negligible GWPs and satisfactory operation performance for ultra-low applications. In practice, additional safety measures are required for this refrigerant pair since they are highly flammable. If the safety measures are taken in place, R1270/R170 is a convenient alternative. However, the performance of proposed refrigerant pair should be examined in detail and compared with the real applications.

A cascade system using both R404A/R508B and R1270/R170 refrigerant pairs is examined theoretically in order to determine the effects of design and operating parameters for ULT conditions. The mathematical models have been developed and implemented in EES for evaluation. The modelling results include the analysis of operating parameters as in the literature which are  $T_E$ ,  $T_C$ , subcooling and superheating temperatures of LTC, temperature difference ( $\Delta T_{CAS}$ ) in the cascade HX, subcooling and superheating temperatures of HTC (Lee et al., 2006; Dopazo, et al. 2009; Getu, et al. 2008; Yilmaz et al. 2014; Sarkar et al., 2013; Parekh and Tailor; 2011). In addition, the operation parameters such as; the refrigerant vapor quality after the expansion valve of LTC and the PCHX capacity which are crucial to determine the LTC subcooling level and system COP are also considered.

### Investigation of Subcooling Degree in LTC

In literature, it is reported that subcooling increases COP whereas superheating decreases it. Therefore, subcooling level should be set as high as possible and superheating value should be set as low as possible. Parekh and Tailor (2011) showed this effect through their cascade system

model. They were determined that increasing the subcooling degree in both LTC and HTC resulted in the increase of the COP. Therefore, the precise determination of the LTC subcooling degree is critical to calculate the maximum overall COP.

The vapor quality at the expansion valve exit is suggested to be selected between 0.10 and 0.20 in the thermodynamics modelling studies of cascade systems (Cengel and Boles, 2007). In this study, the minimum vapor quality of refrigerant is set to the average of the range (0.15). On the other hand, by the utilization of  $IHX_{LTC}$ , the condensed refrigerant from the cascade condenser is subcooled while the saturated refrigerant vapor in evaporator of LTC is superheated. If the refrigerant is too much superheated before entering the compressor, the outlet temperature of the compressor will also increase. This causes a very high desuperheating necessity and requires high capacity of PCHX. The maximum capacity of PCHX is assumed to be 6 kW as a constraint in the present study.

The design and operating parameters are shown for both refrigerant pairs R404A/R508B and R1270/R170 in Table 3 and Table 4, respectively. The corresponding performance results are calculated using the mathematical model equations of the system. In Table 3, two cases of the synthetic refrigerant pair are presented to investigate the performance of the system.

In the first case, the vapor quality after the expansion valve (which is a constraint parameter for the system design) is kept constant at 0.15 while the  $T_{CAS,E}$  is changed from -40 °C to -35 °C. The highest overall COP is calculated to be 0.73 when the subcooling degree, the capacity of PCHX and the desuperheating degree are set to 33.2 K, 5.42 kW and 76.3 K, respectively. When the

$T_{CAS,E}$  decreases from -35 °C to -40 °C COP decreases from 0.73 to 0.71 correspondingly.

In the second case, the total capacity of PCHX is kept constant at 6 kW while  $T_{CAS,E}$  varies from -30 °C to -20 °C. The highest overall COP is calculated to be 0.72 when the subcooling level, the vapor quality after expansion valve and the desuperheating are selected to be 31 K, 0.22 and 77.1 K, respectively. Decreasing  $T_{CAS,E}$  within given range increases the COP from 0.63 to 0.72 as seen in Table 3.

In Table 4, similarly, two cases are investigated for the natural pair of refrigerants. In the first case, the vapor quality is kept constant at 0.15 as in the synthetic option. The  $T_{CAS,E}$  is varied from -40 °C to -35 °C. The highest overall COP is found to be 0.77 when the subcooling degree, the PCHX capacity and the desuperheating degree are set to 33.2 K, 5.92 kW and 107.3 K, respectively. It is found that the COP decreases slightly from 0.77 to 0.76. In the second case, the PCHX capacity is kept constant at 6 kW similarly while the  $T_{CAS,E}$  varies from -30 °C to -20 °C. The highest overall COP is calculated to be 0.76 when the subcooling amount is selected as 31.0 K, the vapor quality after expansion valve is 0.17 and the desuperheating level is 108.9 K. In this case, the  $T_{CAS,E}$  decreases from -20 °C to -30 °C and COP increases from 0.70 to 0.76.

Parekh and Tailor (2011) indicated that COP value might be lower than 1 since the difference between  $T_E$  and  $T_C$  is very high in the ultra-low operational temperatures. From the calculated values given in Table 3 and Table 4, R1270/R170 is found to be a better alternative of R404A/R508B with respect to COP and low environmental trace for ULT conditions.

**Table 3.** Modeling results of the cascade system with R404A/R508B

HTC $T_{CAS,E}$ (°C)	LTC $T_{CAS,C}$ (°C)	LTC $\Delta T_{SUB}$ (K)	Exp. Valve inlet, $T_3$ (°C)	Vapor quality $x_4$	$Q_{PCHX}$ (kW)	$Q_{IHX}$ (kW)	COP	LTC $\Delta T_{DESUP}$ (K)
-40	-32	27.9	-59.9	0.15	4.28	2.77	0.71	61.6
<b>-35</b>	<b>-27</b>	<b>33.2</b>	<b>-60.2</b>	<b>0.15</b>	<b>5.42</b>	<b>3.35</b>	<b>0.73</b>	<b>76.3</b>
<b>-30</b>	<b>-22</b>	<b>31.0</b>	<b>-53.0</b>	<b>0.22</b>	<b>6.00</b>	<b>3.46</b>	<b>0.72</b>	<b>77.1</b>
-25	-17	24.8	-41.8	0.30	6.00	3.25	0.68	68.9
-20	-12	17.9	-29.9	0.40	6.00	2.86	0.63	57.5

**Table 4.** Modeling results of the cascade system with R1270/R170

HTC $T_{CAS,E}$ (°C)	LTC $T_{CAS,C}$ (°C)	LTC $\Delta T_{SUB}$ (K)	Exp. Valve inlet, $T_3$ (°C)	Vapor quality $x_4$	$Q_{PCHX}$ (kW)	$Q_{IHX}$ (kW)	COP	LTC $\Delta T_{DESUP}$ (K)
-40	-32	27.9	-59.9	0.15	4.90	2.02	0.76	91.3
<b>-35</b>	<b>-27</b>	<b>33.2</b>	<b>-60.2</b>	<b>0.15</b>	<b>5.92</b>	<b>2.43</b>	<b>0.77</b>	<b>107.3</b>
<b>-30</b>	<b>-22</b>	<b>31.0</b>	<b>-53.0</b>	<b>0.17</b>	<b>6.00</b>	<b>2.43</b>	<b>0.76</b>	<b>108.9</b>
-25	-17	24.8	-41.8	0.24	6.00	2.16	0.74	101.8
-20	-12	17.9	-29.9	0.30	6.00	1.79	0.70	92.1

### The constant vapor quality

Figure 3 (a) and (b) illustrate that increasing the subcooling level from 5 °C to 50 °C reduces the vapor quality after expansion valve when  $T_{CAS,E}$  changes between -40 °C and -20 °C. The vapor quality after the LTC expansion valve is examined with respect to desired value of 0.15. The vapor quality value intersects with various  $T_{CAS,E}$  values. The LTC operating conditions such as subcooling degree are determined for several temperatures by using these intersection points. It is found that the subcooling degree of LTC ( $\Delta T_{SUB}$ ) varies between 30 °C and 50 °C for R404A/R508B system, on the other hand,  $\Delta T_{SUB}$  changes between 25 °C and 45 °C for R1270/R170 system for the reliable operation of the cascade system.

### The constant PCHX capacity

Subcooling process has to be applied after the cascade HX to reach design evaporation level of  $T_E$  (-86 °C). Subcooling degree can be defined as temperature difference between state 2 and state 3 ( $\Delta T_{SUB,LTC} = T_2 - T_3$ ). It is accomplished by an  $IHX_{LTC}$  located before the expansion valve.

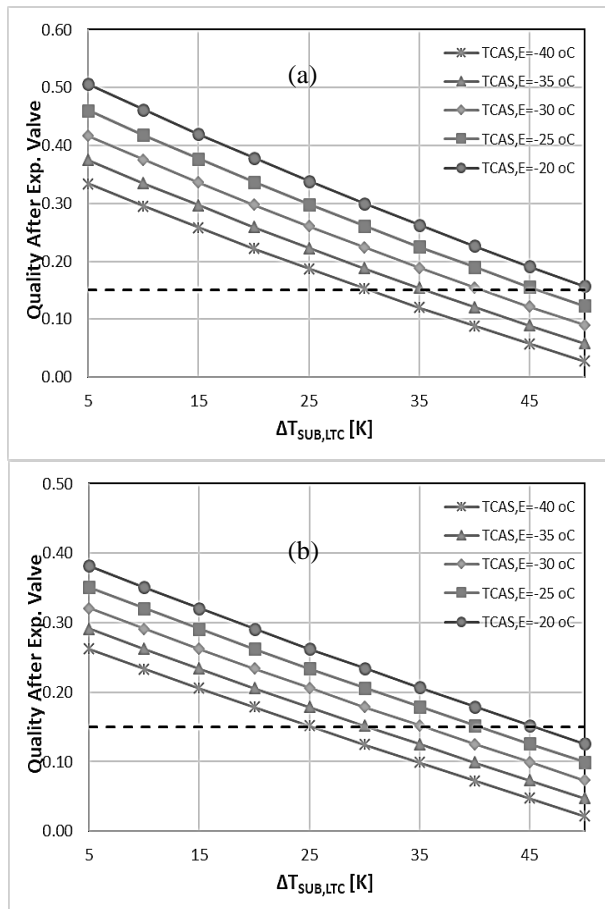

**Figure 3.** Effect of subcooling of LTC on vapor quality after expansion valve for different  $T_{CAS,E}$  (a) R404A/R508B (b) R1270/R170 .

The utilization of  $IHX_{LTC}$  both subcools the refrigerant at the outlet of cascade HX and superheats the refrigerant at the inlet of the compressor as mentioned before. Therefore, the necessary capacity of the PCHX is one of the operation parameters. Another operation parameter is the difference between  $T_{CAS,E}$  and the refrigerant exit temperature ( $T_{1a}$ ) from the PCHX. The maximum temperature difference between  $T_{1b}$  and  $T_{CAS,E}$  is assumed to be constant at 55 K as in the real applications (SWEP Company, 2016). When  $T_{CAS,E}$  is chosen to be -40°C, the lowest value of  $T_{1a}$  should be 15 °C, if the 6 kW PCHX capacity is considered. The high values of  $T_1$  and  $T_6$  indicate the high subcooling necessity in  $IHX_{LTC}$ .

Figure 4 (a) and (b) display that increasing the subcooling level from 5 °C to 50 °C rises the PCHX capacity while  $T_{CAS,E}$  changes between -40 °C and -20 °C. The PCHX capacity is chosen to be 6 kW as the desired condition. The PCHX capacity value intersects with various  $T_{CAS,E}$  lines so that intersection points correspond to the desired LTC operating conditions such as subcooling degree. The  $\Delta T_{SUB}$  is found between 18 °C and 50 °C for R404A/R508B system whereas the  $\Delta T_{SUB}$  is obtained between 14 °C and 45 °C for R1270/R170 system. However, the vapor quality after expansion valve is set to the maximum possible value of 0.20.

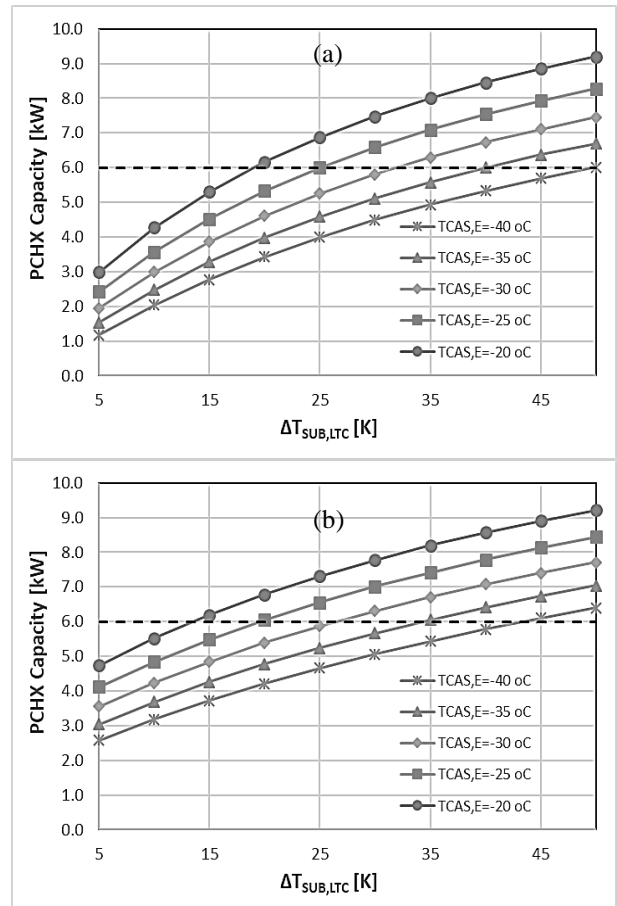

**Figure 4.**Effect of subcooling of LTC on PCHX capacity for different  $T_{CAS,E}$  for (a) R404A/R508B (b) R1270/R170 .



### Effect of LTC Subcooling Degree on COP

In Figure 5 (a) and (b), it is observed that increasing the subcooling level from 5 °C to 50 °C promotes the COP for all  $T_{CAS,E}$  conditions. In addition, the COP of both systems increases for all values of the LTC subcooling degree while the  $T_{CAS,E}$  is decreased from -20 °C to -35 °C.

In this case study, the  $T_E$  is kept constant at -86 °C for ULT operation. Decreasing  $T_E$  value decreases also the  $T_{CAS,E}$  in general. From the calculation results of model equations, it is concluded that the lower value of  $T_{CAS,E}$  affects the system COP positively. As a result, the highest COP is calculated (0.73) for the subcooling degree of 33.2 °C at R404A/R508B system along with the selected  $T_{CAS,E}$  at -35 °C. Likewise, the highest COP is calculated (0.77) for the subcooling degree about 33.2 °C for R1270/R170 system when  $T_{CAS,E}$  is -35 °C.

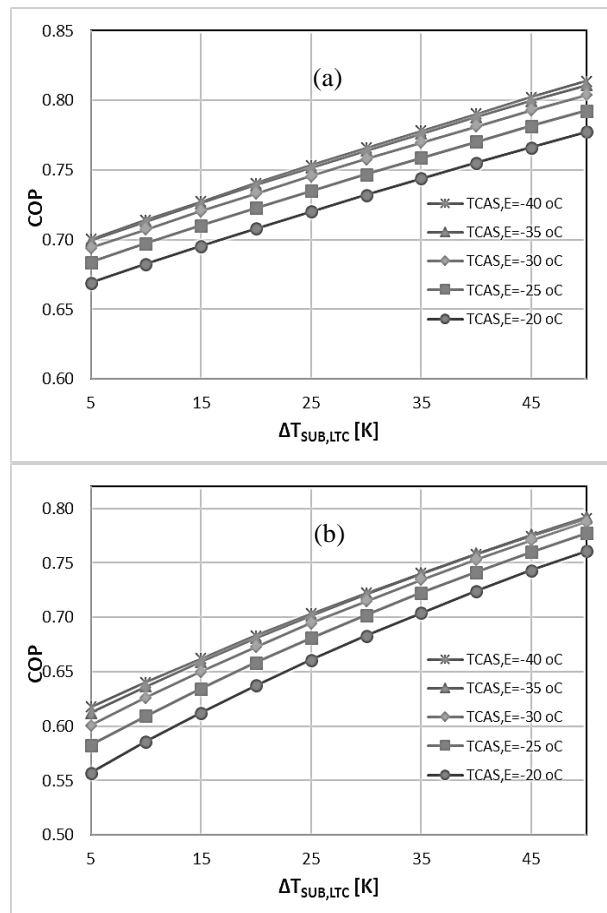

**Figure 5.** Effect of subcooling of LTC on COP for different evaporation temperature of HTC ( $T_{CAS,E}$ ) for (a) R404A/R508B (b) R1270/R170.

### Effect of Evaporation Temperatures of LTC and HTC on the COP

The effect of the operating parameters;  $T_E$  of LTC and  $T_{CAS,E}$  of HTC on the COP is investigated and compared for two refrigerant pairs.

Figure 6 shows that increasing  $T_E$  of LTC results in the increase of COP for both R404A/R508B and

R1270/R170 systems. It is also found that the natural refrigerant pair R1270/R170 results in higher COP than the synthetic refrigerant pair R404A/R508B for all  $T_E$  values between -61 °C and -86 °C. In Figure 7, varying the  $T_{CAS,E}$  between -40 °C and -20 °C shows a maximum value of COP about -35 °C for both refrigerant pairs.

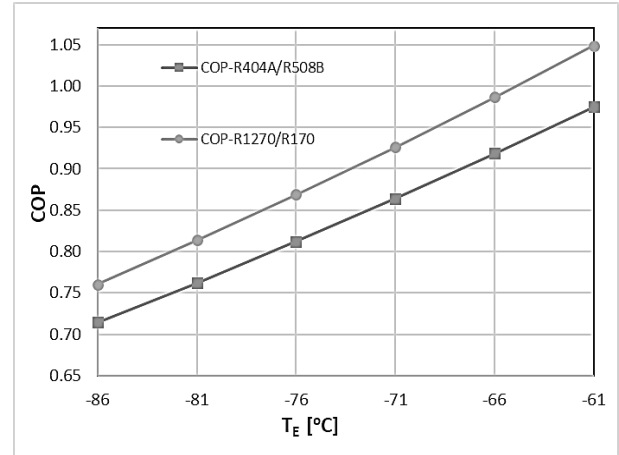

**Figure 6.** Effect of the LTC side  $T_E$  of on COP

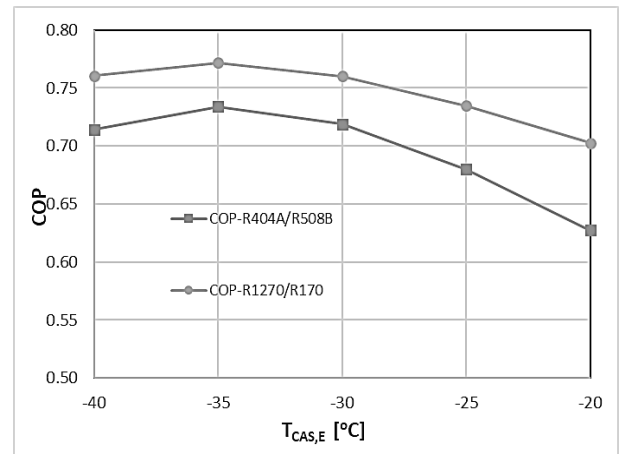

**Figure 7.** Effect of  $T_{CAS,E}$  on COP

### Effect of HTC Condensation Temperature ( $T_c$ ) of HTC on COP

In Figure 8 (a) and (b), it is seen that increasing the  $T_c$  from 30 °C to 55 °C, representing the effect of the ambient conditions, reduces the COP values for all  $T_{CAS,E}$  values of HTC.

It is observed that the R1270/R170 pair has relatively higher COP values compared to the R404A/R508B pair for all  $T_c$  and  $T_{CAS,E}$ . In addition, it is seen that the increase of the condensation temperature results in decrease in COP for both cases. However, the difference is found higher for R404A/R508B pair.

### Impact of the Cascade Refrigerant Pairs on the Environment.

In this section, the effect of using different refrigerant pairs on the system performance and the environment has been examined. Furthermore, TEWI values of two

refrigerant options, R404A/R508B (System 1) and R1270/R170 (System 2), have been investigated for the leakage of the refrigerants to the atmosphere. In this case study,  $T_C$ ,  $T_E$  and  $T_{CAS,E}$  are chosen to be 40 °C, -86 °C, and

-35 °C, respectively. The  $\Delta T_{CAS}$  is assumed to be constant at 8 K,  $\Delta T_{SUB}$  is 30 °C and  $\Delta T_{SUP}$  of LTC is 20 °C.

The TEWI analysis assumptions are summarized in Table 5. The corresponding values of the parameters used in Eq. 1 are also listed in the table. The mass flow rate requirements for different refrigerants are initially calculated. Then the total GWP values of each refrigerant is obtained. For the chosen refrigeration capacity of 11 kW, mass flow rates of System 1 refrigerants are found as 0.14 kg/s for R404A and 0.08 kg/s for R508B. On the other hand, the mass flow rates of System 2 refrigerants are calculated as 0.05 kg/s for R1270 and 0.03 kg/s for R170. The amount of the refrigerant charge is estimated according to receiver's volume (Sinar, 2018). In addition, the compressor power consumptions of of System 1 and 2 are given in Table 6.

TEWI analysis plays an important role in the selection of environmentally friendly refrigerant pair of the systems. For comparison between the Systems 1 and 2, the TEWI values are calculated using Equation (1) and the  $COP_{max}$  of systems are presented in Table 6.

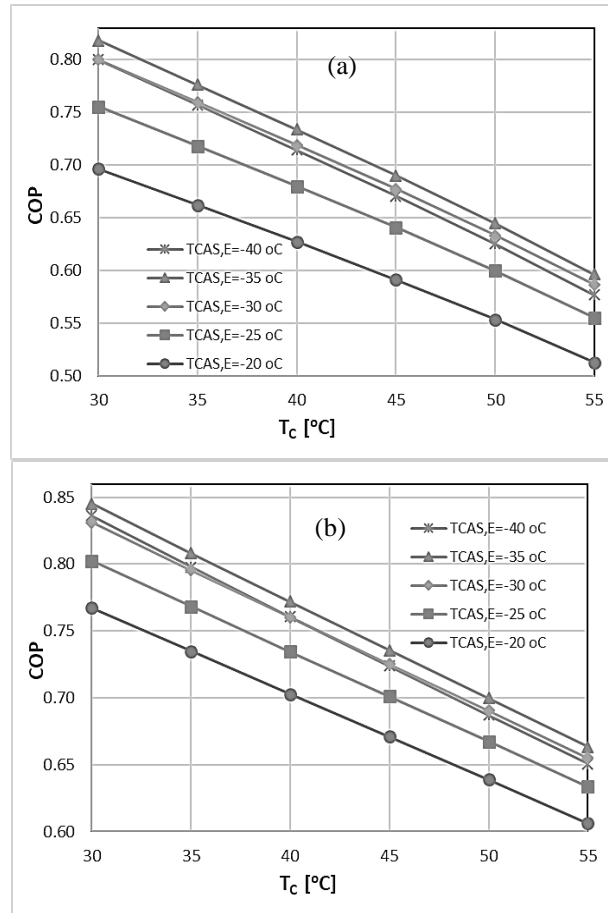

**Figure 8.** Effect of HTC condensation temperature ( $T_C$ ) of on COP for different evaporation temperature of HTC ( $T_{CAS,E}$ ) for (a) R404A/R508B (b) R1270/R170.

**Table 5.** TEWI analysis assumptions (AIRAH, 2012)

$m_{Ref}^*$ (kg)	$m_{Ref} = \dot{m}_{Ref} \times 240$
$L_{annual}$ (%)	12.5
N (year)	15
A (%)	0.7
$\beta^*$ (kgCO <sub>2</sub> /kWh)	0.65
Operation time (h/year)	6570
$GWP_{Ref}$	$GWP_{R404A} = 3922$ $GWP_{R508B} = 11698$ $GWP_{R1270} = 1.8$ $GWP_{R170} = 6$

\*(Sinar, 2018),\*\*(Horton, 2002)

**Table 6.** Comparison of TEWI and  $COP_{max}$  values for Systems 1 and 2

	Systems 1 (R404A/R508B)		Systems 2 (R1270/R170)	
	Refrigerant charge (kg)	33.6	19.92	12
Refrigerant leakage rate (%/year)	0.125	0.125	0.125	0.125
Service life (years)	15	15	15	15
Recycling factor	0.7	0.7	0.7	0.7
GWP	3922	11698	1.8	6
Direct CO <sub>2</sub> emission of refrigerants (kg CO <sub>2</sub> )	286,620	506,828	46.98	93.96
<b>Total direct CO<sub>2</sub> emission of refrigerants (kg CO<sub>2</sub>)</b>	<b>793,447.31</b>		<b>140.94</b>	
Power consumption (kW)	8.71	6.96	7.81	7.09
Operation (h/year)	6570		6570	
Service life (year)	15		15	
CO <sub>2</sub> emission factor	0.65		0.65	
<b>Indirect CO<sub>2</sub> emission (kg CO<sub>2</sub>)</b>	<b>1,003,781.0</b>		<b>954,456.8</b>	
<b>TEWI equivalent CO<sub>2</sub> emission (kg CO<sub>2</sub>)</b>	<b>1,797,228.3</b>		<b>954,597.7</b>	
<b><math>COP_{max}</math></b>	<b>0.73</b>		<b>0.77</b>	

It is found that System 1 with a synthetic refrigerant pair emits considerably higher amounts of greenhouse gases than System 2 during their lifetime. According to the TEWI values, high GWP of System 1 shows the higher contribution to the direct CO<sub>2</sub> emission. On the other hand, the indirect part of TEWI values are found almost the same for both systems. When the total TEWI levels are compared, System 1 shows almost twice more emissions compared to System 2. It is concluded that as well as the natural refrigerant alternative has higher COP (0.77) it also results in the better environmental performance compared to its synthetic counterpart.

## CONCLUSIONS

This study evaluates two types of refrigerant pairs, namely R404A/R508B and R1270/R170, corresponding to the synthetic and natural refrigerant options in terms of performance and environmental considerations for a ULT cascade refrigeration system. It is found that the COP of the natural refrigerant pair, R1270/R170, is calculated slightly higher (0.77) than that of the R404A/R508B case (0.73). Furthermore, the TEWI value of the natural refrigerant pair is approximately half of the that of the synthetic refrigerant pair. Thus, R1270/R170 is the better environmentally friendly candidate at ULT applications with higher COP performance.

The proposed ULT cascade system using both refrigerant alternatives, R404A/R508B and R1270/R170, are extensively investigated in order to determine the effects of design and operating parameters on the COP. The following outcomes are obtained from the study:

- The vapor quality after expansion valve is set to 0.15 as the first constraint while the effect of  $T_{CAS,E}$  has been evaluated at various temperatures from -40 °C to -20 °C for both refrigerant alternatives. The best COP value is obtained for the  $T_{CAS,E}$  value of -35 °C and the optimum  $\Delta T_{SUB}$  is found to be 33.2 °C for both R404A/R508B and R1270/R170 cases. The COP values are found 0.77 and 0.73 for the natural and the synthetic refrigerant pairs, respectively.
- The PCHX capacity is selected to be 6 kW as the second constraint. The vapor quality after expansion valve is considered to be less than 0.20. In this case, R404A/R508B refrigerant pair satisfies this constraint for  $T_{CAS,E}$  at -35 °C and the subcooling degree of LTC at 33.2 °C. On the other hand, R1270/R170 alternative satisfies the design condition at most -30 °C and 31 °C for the  $T_{CAS,E}$  and  $\Delta T_{SUB}$  of LTC, respectively. The replacement of synthetic refrigerant pair with natural refrigerant improves efficiency about 5%.
- It is observed that increasing the  $T_E$  results in the increase of COP for both types of refrigerant pairs as expected. The natural refrigerant case results in the higher COP than the synthetic solution for all

evaporation temperatures of LTC between -86 °C and -60 °C.

- Increasing  $T_{CAS,E}$  up to about -35 °C increases the COP. For lower values of the  $T_{CAS,E}$ , less than -35 °C, the COP value decreases. However, it is also revealed that the COP values of the natural refrigerant option are higher than those of the synthetic refrigerant option when the  $T_{CAS,E}$  is varied between -40 °C and -20 °C.
- It is found that increasing the  $T_C$  from 30 °C to 55 °C reduces the COP values for all  $T_{CAS,E}$ . It is also observed that the natural refrigerant option has relatively higher COP values compared to the synthetic refrigerant option for all condensation and evaporation temperatures of HTC.
- The environmental trace of both refrigerant options are also evaluated for the leakage of refrigerants scenario in terms of TEWI values. It is found that the system with synthetic refrigerant option causes almost twice more CO<sub>2</sub> emissions than the natural option.

## REFERENCES

- AIRAH, Methods of Calculating Total Equivalent Warming Impact (TEWI) 2012, Best Practice Guidelines. The Australian Institute of Refrigeration, Air Conditioning and Heating
- ASHRAE, 2016, "Designation and Safety Classification of Refrigerants," ANSI/ASHRAE, Atlanta, GA, Standard No. 34.
- ASHRAE Handbook—Refrigeration, 2010, "American Society of Heating, Refrigerating and Air-Conditioning Engineers, Inc.," (SI Edition).
- ASHRAE, 2000, "Standard Method of Testing Forced Circulation Air Cooling and Air Heating Coils," ANSI/ASHRAE, Atlanta, GA, Standard No. 33.
- Babiloni, A.M., Joybari, M.M., Esbri, J.N., Cervera, A.B., Albuixech, M.A., Moles, M., 2019, Ultralow-temperature refrigeration systems: Configurations and refrigerants to reduce the environmental impact, *International Journal of Refrigeration*, doi:<https://doi.org/10.1016/j.ijrefrig.2019.11.016>
- Bhattacharyya, S., Mukhopadhyay, S., Kumar, A., Khurana, R.K. and Sarkar, J., 2005, "Optimization of a CO<sub>2</sub>-C<sub>3</sub>H<sub>8</sub> Cascade System for Refrigeration and Heating," *Int. J. of Refrigeration*, **8**, pp. 1284–1292.
- Bhattacharyya, S., Garai, A., and Sarkar, J., 2009, "Thermodynamic Analysis and Optimization of a Novel N<sub>2</sub>O-CO<sub>2</sub> Cascade System for Refrigeration and Heating," *Int. J. of Refrigeration*, **32**, pp.1077–1084.
- Bingming, W., Huagen, W., Jianfeng, L., and Ziwen, X., 2009, "Experimental Investigation on the Performance of NH<sub>3</sub>/CO<sub>2</sub> Cascade Refrigeration

System with Twin-screw Compressor,” *Int. J. of Refrigeration*, **32**, pp.1358–1365.

Brunin, O., Feidt, M., Hivet, B., (1997), Comparison of the working domains of some compression heat pumps and a compression-absorption heat pump, *International Journal of Refrigeration*, 20-5, 308-318.  
Cengel, Y. A., and Boles, M. A., 2007, “*Thermodynamics: An Engineering Approach*”, Sixth ed. McGraw-Hill, Singapore

Dopazo, J.A., Seara, J. F., Sieres, J., and Ufia, F.J., 2009, “Theoretical Analysis of a CO<sub>2</sub>-NH<sub>3</sub> Cascade Refrigeration System for Cooling Applications at Low Temperatures,” *Appl. Therm. Eng.*, **29**(8-9) pp.1577-1583.

Dopazo, J. A., and Seara, J.F. 2011, “Experimental Evaluation of a Cascade Refrigeration System Prototype with CO<sub>2</sub> and NH<sub>3</sub> for Freezing Process Applications,” *Int. J. of Refrigeration*, **34**, pp. 257-267.

GEA Germany 2016,  
<https://vap.gea.com/stationaryapplication/Pages/Product.aspx?ItemObjectID=TS&Size=HGZX7&ProductID=2039>

Getu, H., and Bansal, P., 2008, “Thermodynamic Analysis of an R744-R717 Cascade Refrigeration System,” *Int. J. of Refrigeration*, **31**(1), pp.45–54.

Gong, M., Zhaohu, S., Jianfeng, W., Zhang, Y., Meng, C., and Zhou, Y. 2009, “Performance of R170 Mixtures as Refrigerants for Refrigeration at -80°C Temperature Range,” *Int. J. of Refrigeration*, **32**, pp. 892-900.

Horton, W.T., Modelling of secondary loop refrigeration systems in supermarket applications, Purdue University, PhD thesis, 2002.

IPCC. *Climate Change 2013: The Physical Science Basis*, Cambridge University Press, Cambridge, United Kingdom and New York, USA, 2013.

JP 5 B-A-CVBP - Grundfos Product Center, 2016,  
<https://product.selection.grundfos.com/product-detail>  
(Accessed 24 December 2016)

Kilicarslan, A., and Hosoz, M., 2010, “Energy and Irreversibility Analysis of a Cascade Refrigeration System for Various Refrigerant Couples,” *Energy Convers. Manag.*, 51 (12), pp.2947-2954.

Klein, S.A., 2017, “Engineering Equation Solver (EES)”, Academic Professional V10.294, F-Chart Software, Madison, WI, USA.

Kruse, H., and Russmann, H., 2006, “The Natural Fluid Nitrous oxide-An option as Substitute for Low Temperature Synthetic Refrigerants,” *Int. J. of Refrigeration* **29** (5), 799-806.

Lee, T., S., Liu, C., H., and Chen, T., W., 2006, “Thermodynamic Analysis of Optimal Condensing Temperature of Cascade-condenser in CO<sub>2</sub>/NH<sub>3</sub> Cascade Refrigeration Systems,” *Int. J. of Refrigeration*, **29** (7), pp. 1100–1108.

Mancuhan, E., 2019, “A comprehensive comparison between low and medium temperature application refrigerants at a two-stage refrigeration system with flash intercooling,” *Thermal Science and Engineering Progress*, **13**,  
<https://doi.org/10.1016/j.tsep.2019.100357>.

Messineo, A., 2012, “R744-R717 Cascade Refrigeration System: Performance Evaluation Compared with a HFC Two-stage System,” *Energy Procedia*, **14**, pp.56-65.

Minh, N., Q., Hewitt, N., J., and Eames, P. C., 2006, “Improved Vapor Compression Refrigeration Cycles: Literature Review and Their Application to Heat Pumps,” *International Refrigeration and Air Conditioning Conference*, Purdue, USA.

Nicola, D. G., Polonara, F., Stryjek, R., and Arteconi, A., 2011, “Performance of Cascade Cycles Working with Blends of CO<sub>2</sub>+Natural Refrigerants,” *Int. J. of Refrigeration*, **34**, pp. 1436-1445.

Parekh, A. D., and Tailor, P.R., 2011, “Thermodynamic Analysis of R507A-R23 Cascade Refrigeration System”, *Int. J. of Mechanical and Mechatronics Eng.*, 5 (9), pp. 1919-1923.

Sarkar, J., Bhattacharyya, S., and Lal, A., 2013, “Performance Comparison of Natural Refrigerants Based Cascade Systems for ULT Applications,” *Int. J. of Sustainable Energy*, **32**(5), pp. 406-420.

Sinar, U., Numerical analysis of a cascade refrigeration system operating at ultra-low temperatures, Marmara University, Master’s Thesis, 2018.

Sun, Z., Wang, Q., Xie, Z., Liu, S., Su, D., Cui, Q., 2019, Energy and exergy analysis of Low GWP refrigerants in cascade refrigeration system, *Energy*, 170, 1170-1180

SWEP Company 2016,  
<http://www.swep.cn/refrigerant-handbook/10.-systems/asdf2/>

Syaka, N. D. R. B., and Alhamid, M. I., 2011, “Cascade Refrigeration System Using Mixture of Carbon dioxide and Hydrocarbons for Low Temperature Applications,” *J. of Eng. and Appl. Sci.*, **6** (6), pp. 379-386.

Wadell, R., P., 2005, “Design of Compact Evaporators for ULT Thermal Management of Microprocessors”, MS thesis, Georgia Institute of Technology.

Yilmaz B., Erdönmez N., Sevindir M., and Mancuhan E. 2014, "Thermodynamic Analysis and Optimization of Cascade Condensing Temperature of a CO<sub>2</sub> (R744)/404A Cascade Refrigeration System," 15<sup>th</sup> International Refrigeration and Air Conditioning Conference, West Lafayette, IN, Paper No. 2958-10.

Yilmaz B., Mancuhan E., and Erdonmez N., 2018, "A Parametric Study on a Subcritical CO<sub>2</sub>/NH<sub>3</sub> Cascade Refrigeration System for Low Temperature Applications," J. Energy Resour. Technol., **140**, pp. 1-7.

Van Orshoven, D., Klein, S. A. and Beckman, W. A., 1993, An Investigation of Water as a Refrigerant, J. Energy Resour. Technol **115**(4), pp. 257-263.

Vidhi, R., Kuravi, S., Goswami, D. Y., Stefanakos E., and Sabau, A. S., 2013, "Organic Fluids in a Supercritical Rankine Cycle for Low Temperature Power Generation", J. Energy Resour. Technol **135**(4), 042002.

Vijayaraghavan S., and Goswami, D. Y., 2005, Organic Working Fluids for a Combined Power and Cooling Cycle, J. Energy Resour. Technol **127**(2), pp. 125-130.

**Barış YILMAZ** graduated from Nuclear Engineering Department of Hacettepe University in 1999. He received his MSc degree from Mechanical Engineering Department of Marmara University in 2002. He received PhD degree from Mechanical Engineering Department of Marmara University and University of Orleans (France) within the frame of the joint PhD program. He is currently working in the Mechanical Engineering Department of Marmara University as an Assistant Professor.

**Ebru MANÇUHAN** graduated from Mechanical Engineering Department of Uludağ University in 1981. She received her MSc degree from Mechanical Engineering Department of Uludağ University in 1985. She received PhD degree from Mechanical Engineering Department of Yıldız Technical University in 1997. She is currently working in the Chemical Engineering Department of Marmara University as an Associate Professor.

**Deniz YILMAZ** graduated from Mechanical Engineering Department of Kocaeli University in 2000. She received her MSc degree from Mechanical Engineering Department of Yıldız Technical University in 2003. She received PhD degree from Mechanical Engineering Department of Istanbul Technical University in 2011. She is currently working in the Mechanical Engineering Department of Arel University as an Assistant Professor.

Copyright of *Isi Bilimi ve Teknigi Dergisi / Journal of Thermal Science & Technology* is the property of Turkish Society for Thermal Sciences & Technology and its content may not be copied or emailed to multiple sites or posted to a listserv without the copyright holder's express written permission. However, users may print, download, or email articles for individual use.